

Neosys Technology Inc.

PCIe-PoE334LP

User Manual
Revision 1.0

Table of Contents

Table of Contents	2
Legal Information	3
Contact Information	4
Notices	5
Safety Precautions	6
Service and Maintenance	7
ESD Precautions	7
About This Manual	8
1 Introduction	
1.1 PCIe-PoE334LP Specification.....	10
1.2 Dimension	11
2 Setting Up Your PCIe-PoE334LP Card	
2.1 Unpacking Your PCIe-PoE334LP	12
2.2 Superior View.....	12
2.3 Status LEDs	13
2.4 DIP Switches	14
2.4.1 Switching Between PoE (af) and PoE ⁺ (at) Mode	14
2.4.2 Board ID Settings.....	15
3 PCIe-PoE334LP Card Installation	
3.1 Hardware Installation	17
3.2 Software Installation.....	19
4 Driver and Network Settings	
4.1 Jumbo Frame	20
4.2 Receive Buffers	24
4.3 Transmit Buffers	29
Appendix A Using Per-Port PoE On/Off Control	
Driver Installation	34
Per-Port On/Off Control Function Reference.....	37
PCI_GetStatusPoEPort	37
PCI_EnablePoEPort.....	38
PCI_DisablePoEPort.....	39

Legal Information

All Neousys Technology Inc. products shall be subject to the latest Standard Warranty Policy.

Neousys Technology Inc. may modify, update or upgrade the software, firmware or any accompanying user documentation without prior notice. Neousys Technology Inc. will provide access to these new software, firmware or documentation releases from download sections of our website or through our service partners.

Before installing any software, applications or components provided by a third party, customer should ensure that they are compatible and interoperable with Neousys Technology Inc. product by checking in advance with Neousys Technology Inc.. Customer is solely responsible for ensuring the compatibility and interoperability of the third party's products. Customer is further solely responsible for ensuring its systems, software, and data are adequately backed up as a precaution against possible failures, alternation, or loss.

For questions in regards to hardware/ software compatibility, customers should contact Neousys Technology Inc. sales representative or technical support.

To the extent permitted by applicable laws, Neousys Technology Inc. shall NOT be responsible for any interoperability or compatibility issues that may arise when (1) products, software, or options not certified and supported; (2) configurations not certified and supported are used; (3) parts intended for one system is installed in another system of different make or model.

Contact Information

Headquarters
(Taipei, Taiwan)

Neosys Technology Inc.

15F, No.868-3, Zhongzheng Rd., Zhonghe Dist., New Taipei City, 23586, Taiwan

Tel: +886-2-2223-6182 Fax: +886-2-2223-6183 [Email](#), [Website](#)

Americas
(Illinois, USA)

Neosys Technology America Inc.

3384 Commercial Avenue, Northbrook, IL 60062, USA

Tel: +1-847-656-3298 [Email](#), [Website](#)

China

Neosys Technology (China) Ltd.

Room 612, Building 32, Guiping Road 680, Shanghai

Tel: +86-2161155366 [Email](#), [Website](#)

Notices

Copyright	All rights reserved. This publication may not be reproduced, transmitted, transcribed, stored in a retrieval system, or translated into any language or computer language, in any form or by any means, electronic, mechanical, magnetic, optical, chemical, manual or otherwise, without the prior written consent of Neosys Technology, Inc.
Disclaimer	This manual is intended to be used as an informative guide only and is subject to change without prior notice. It does not represent commitment from Neosys Technology Inc. Neosys Technology Inc. shall not be liable for any direct, indirect, special, incidental, or consequential damages arising from the use of the product or documentation, nor for any infringement on third party rights.
Patents and Trademarks	Neosys, the Neosys logo, Expansion Cassette, MezIO™ are registered patents and trademarks of Neosys Technology, Inc. Windows is a registered trademark of Microsoft Corporation. Intel®, Core™ are registered trademarks of Intel Corporation NVIDIA®, GeForce® are registered trademarks of NVIDIA Corporation All other names, brands, products or services are trademarks or registered trademarks of their respective owners.
FCC Conformity	This equipment has been tested and found to comply with the limits for a Class A digital device, pursuant to part 15 of the FCC Rules. These limits are designed to provide reasonable protection against harmful interference when the equipment is operated in a commercial environment. This equipment generates, uses, and can radiate radio frequency energy and, if not installed and used in accordance with the instruction manual, may cause harmful interference to radio communications. Operation of this equipment in a residential area is likely to cause harmful interference in which case the user will be required to correct the interference at his own expense.
CE Conformity	The product(s) described in this manual complies with all applicable European Union (CE) directives if it has a CE marking. For computer systems to remain CE compliant, only CE-compliant parts may be used. Maintaining CE compliance also requires proper cable and cabling techniques.

Safety Precautions

Read these instructions carefully before you install, operate, or transport the system.

- Install the system or DIN rail associated with, at a sturdy location
- Install the power socket outlet near the system where it is easily accessible
- Secure each system module(s) using its retaining screws
- Place power cords and other connection cables away from foot traffic.
- Do not place items over power cords and make sure they do not rest against data cables
- Shutdown, disconnect all cables from the system and ground yourself before touching internal modules
- Ensure that the correct power range is being used before powering the device
- Should a module fail, arrange for a replacement as soon as possible to minimize down-time
- If the system is not going to be used for a long time, disconnect it from mains (power socket) to avoid transient over-voltage

Service and Maintenance

- ONLY qualified personnel should service the system
- Shutdown the system, disconnect the power cord and all other connections before servicing the system
- When replacing/ installing additional components (expansion card, memory module, etc.), insert them as gently as possible while assuring proper connector engagement

ESD Precautions

- Handle add-on module, motherboard by their retention screws or the module's frame/ heat sink.
- Avoid touching the PCB circuit board or add-on module connector pins
- Use a grounded wrist strap and an anti-static work pad to discharge static electricity when installing or maintaining the system
- Avoid dust, debris, carpets, plastic, vinyl and styrofoam in your work area.
- Do not remove any module or component from its anti-static bag before installation

About This Manual

This manual introduces and describes how to setup/ install Neosys Technology PCIe-PoE334LP. As one of the first industrial low profile Power over Ethernet expansion cards on the market, it offers expandability, stability, flexibility and fast Ethernet access to peripheral devices.

Revision History

Version	Date	Description
1.0	May. 2020	Initial release

1 Introduction

PCIe-PoE334LP is the latest member of Neosys' well-acclaimed PoE NIC card family. It is the world's first low-profile form factor PoE card to integrate 4-port, server-grade GigE controller and 802.3at PoE+. The low-profile form-factor makes PCIe-PoE334LP an ideal solution with commercial off-the-shelf 2U server systems.

PCIe-PoE334LP is designed with state-of-the-art Intel® I350-AM4 GigE controller to offer exceptional Ethernet performance. It inherits Neosys' proven PoE technology to power your machine vision cameras and mobile surveillance IP cameras. In addition, PCIe-PoE334LP features solid surge protection design compliant with IEC 61000-4-5 Class 2. It is capable of withstanding 1 kV surge and 8 kV ESD on signal lines. This is particularly valuable for outdoor surveillance system or factory automation equipment where power surge may happen and damage the system through the Ethernet connection.

Incorporating low-profile form-factor and robust surge protection, PCIe-PoE334LP defines a new category of PoE card - a small and yet rugged solution for server systems and tough enough for industrial conditions.



1.1 PCIe-PoE334LP Specification

Bus interface	4-lanes, Gen2 PCI Express interface
Gigabit Ethernet Port	4x GigE ports by Intel® I350-AM4 controller, supporting 9.5 kB jumbo frame, teaming and IEEE 1588
PoE Capability	In compliant with IEEE 802.3at-2009 (PoE+), each port delivers up to 25.5 W of power 75W total power budget (due to power limitation of PCI Express bus)
Cable Requirement	CAT-5e or CAT-6 cable, 100 meters maximum
Power requirement	Maximum 1.2A @ 3.3 V from PCI Express bus Maximum 6.2A @ 12 V from PCI Express bus
EMC	CE Class A, according to EN 55022/55024 FCC Class A, according to FCC Part 15, Subpart B
EMS	IEC 61000-4-x Class/ Level 2
Operating temperature	0°C ~ 55°C with air flow
Dimension	167.7 m (W) x 68.9 mm (H)

1.2 Dimension

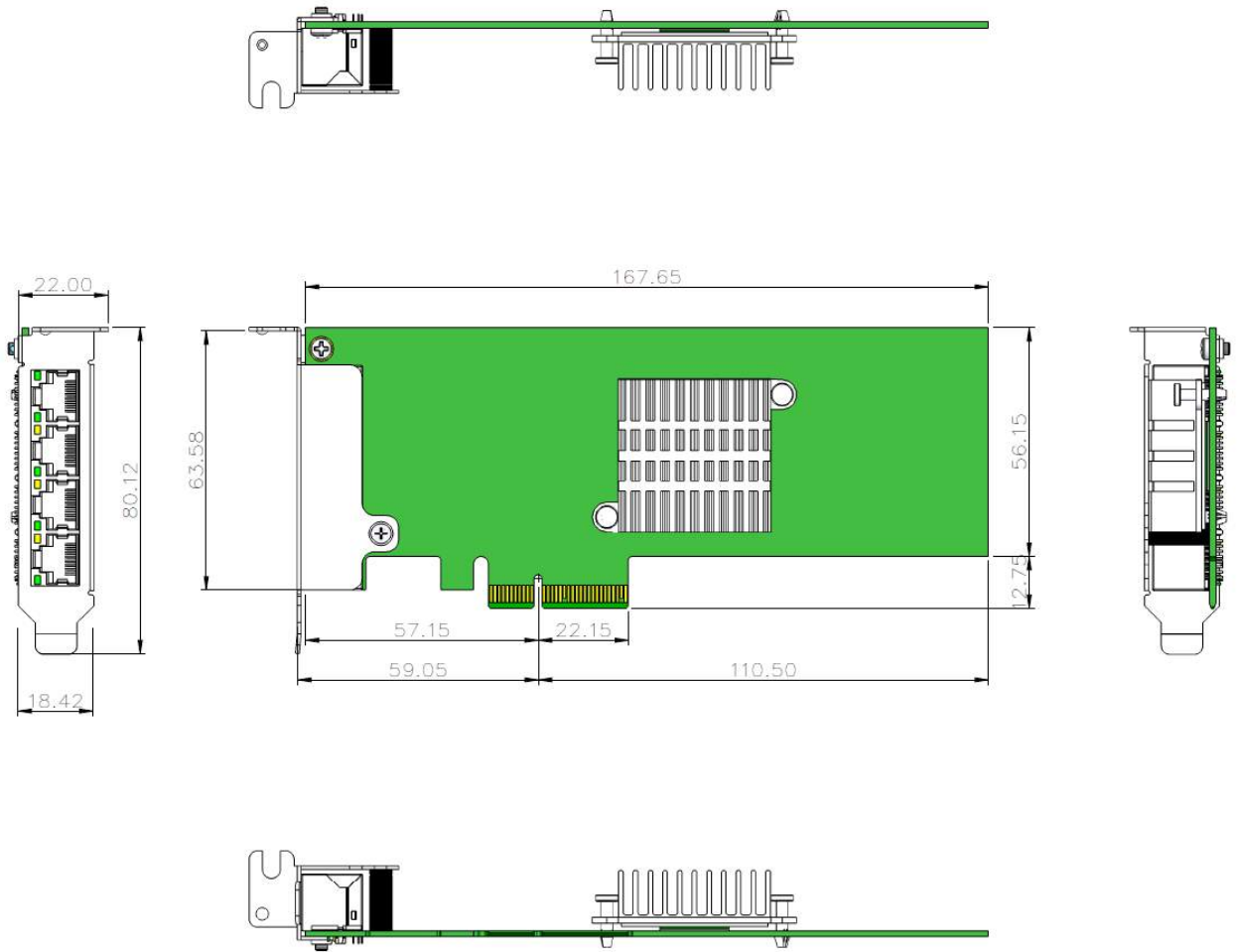

NOTE

All measurements are in millimeters (mm).

2 Setting Up Your PCIe-PoE334LP Card

2.1 Unpacking Your PCIe-PoE334LP

Upon receiving the PCIe-PoE334LP package, please check immediately if the package contains all the items listed in the following table. If any item is missing or damaged, please contact your local dealer or Neousys Technology.

Item	Description	Qty
1	PCIe-PoE334LP	1
2	Full-height Bracket	1
3	Drivers & Utilities Disc	1

2.2 Superior View

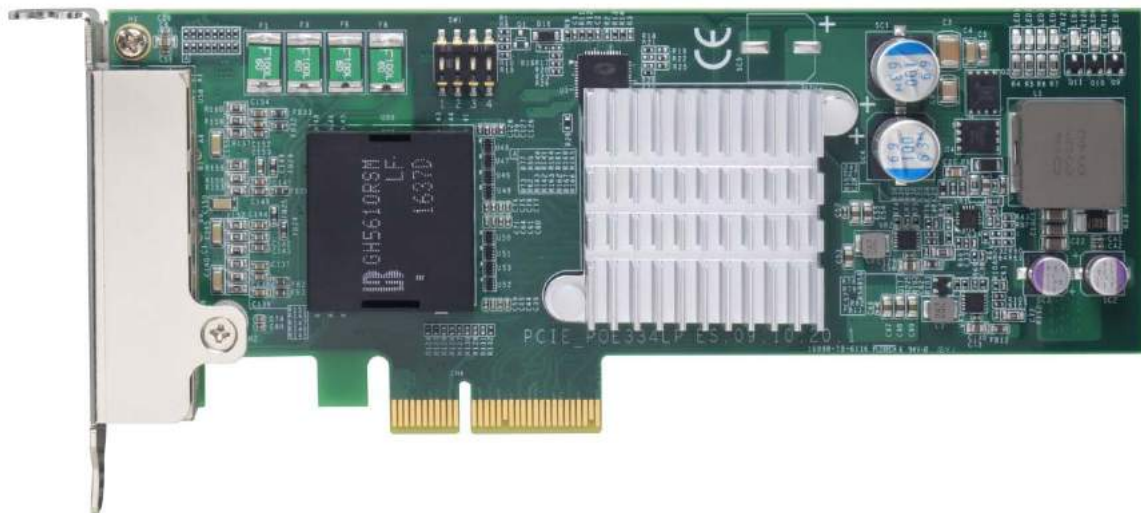

2.3 Status LEDs

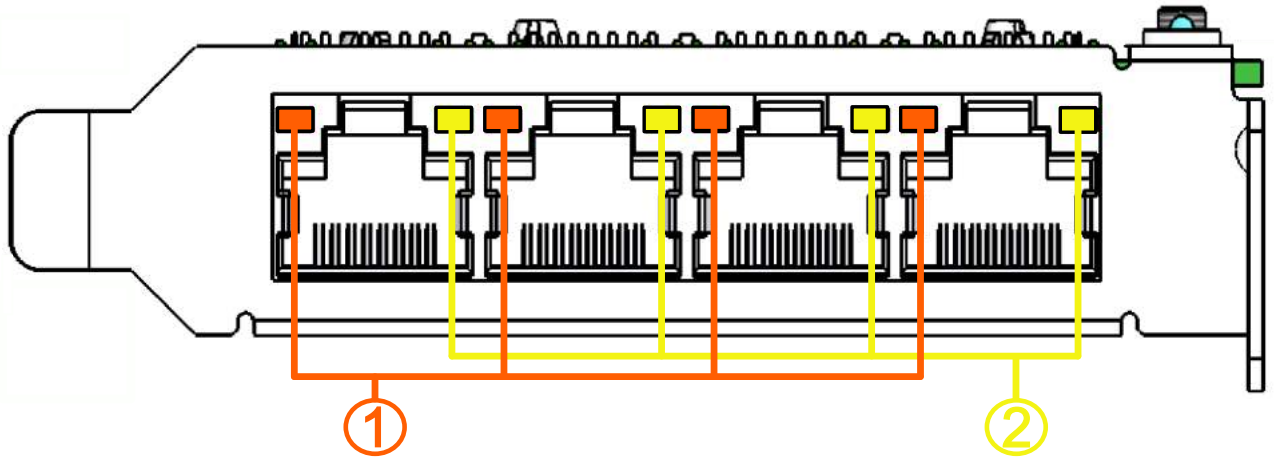

Speed LED (1)

LED Color	Status	Description
Green or Orange	Orange	1000 Mbps
	Green	100 Mbps
	Off	10 Mbps

Active/Link LED (2)

LED Color	Status	Description
Yellow	Off	Ethernet port is disconnected
	On	Ethernet port is connected and no data transmission
	Flashing	Ethernet port is connected and data is transmitting/receiving

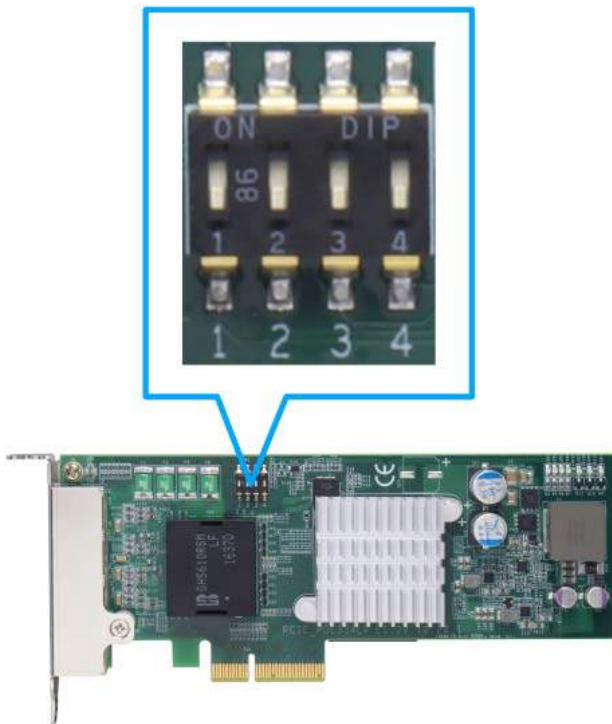

2.4 DIP Switches

PCIe-PoE334LP features individual per-port power on/off control via Neousys' API so you may manually cut off or resume the power delivery to the connected PoE device. This feature is designed for failure recovery in the field to reset connected devices. In case you have installed multiple cards, there is a set of DIP switches (indicated in blue) for users to configure board ID. The board ID can be used as a parameter in API to specify the card.



2.4.1 Switching Between PoE (af) and PoE⁺ (at) Mode

The PoE334LP card offers two modes, users can choose between af mode (IEEE 802.3af) or high at mode (IEEE 802.3at) by configuring DIP switch 4.

Mode	DIP Switch 4 Position	Power Supplied
af	 4	Up to 350mA per port
High at	 4	Up to 720mA per port

2.4.2 Board ID Settings

The following illustrations describe DIP switch board ID settings. When installing multiple cards, please remember to set a different ID for each card.

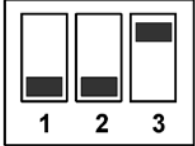
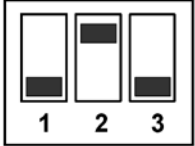
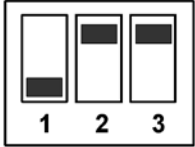
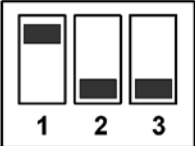
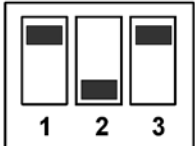
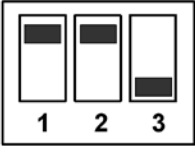
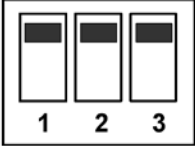
Board ID	DIP Switch Position (P1 ~ P3)
0	
1	
2	
3	
4	
5	
6	
7	

3 PCIe-PoE334LP Card Installation

Once you have set up the DIP switch ID of your PCIe-PoE334LP for multi-card installation, then you are ready to install the PCIe-PoE334LP into the system. To install the PCIe-PoE334LP, please refer to the following procedure.

Before disassembling the system enclosure and installing the PCIe-PoE550X card, please read the following instructions:

- **DO NOT** remove the card out of the anti-static until you are ready to install it into the system.
- It is recommended that only qualified service personnel should install and service this product to avoid injury or damage to the system.
- Please observe all ESD procedures at all times to avoid damaging the equipment.
- Before disassembling your system, please make sure the system has powered off, all cables and antennae (power, video, data, etc.) are disconnected.
- Place the system on a flat and sturdy surface (remove from mounts or out of server cabinets) before proceeding with the installation/ replacement procedure.

3.1 Hardware Installation

1. Save and close all work in progress.
2. Power off and unplug the power cable from the system you wish to install to.
3. Open the chassis (side panel) of the computer you wish to install the PCIe-PoE334LP into.
4. Locate the x4 PCIe slot or a spare and compatible x16/ x8 PCIe slot.
5. Align and insert PCIe-PoE334LP's gold finger into the PCIe slot.

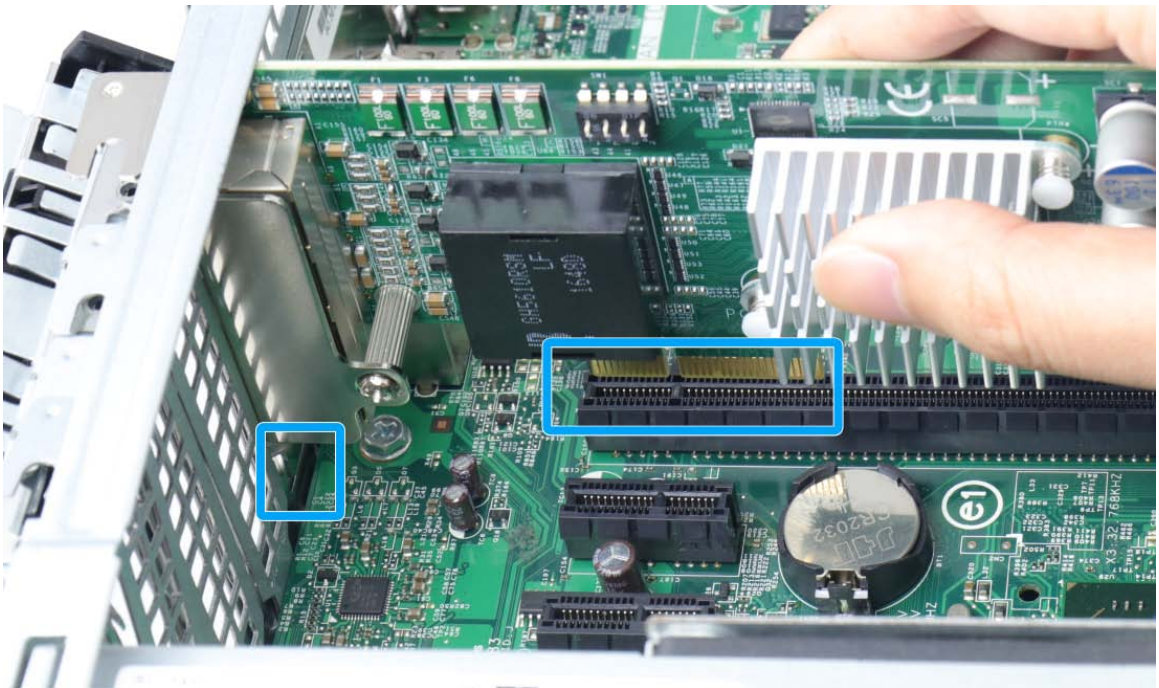

6. Secure the PCIe-PoE334LP to the chassis with a screw.

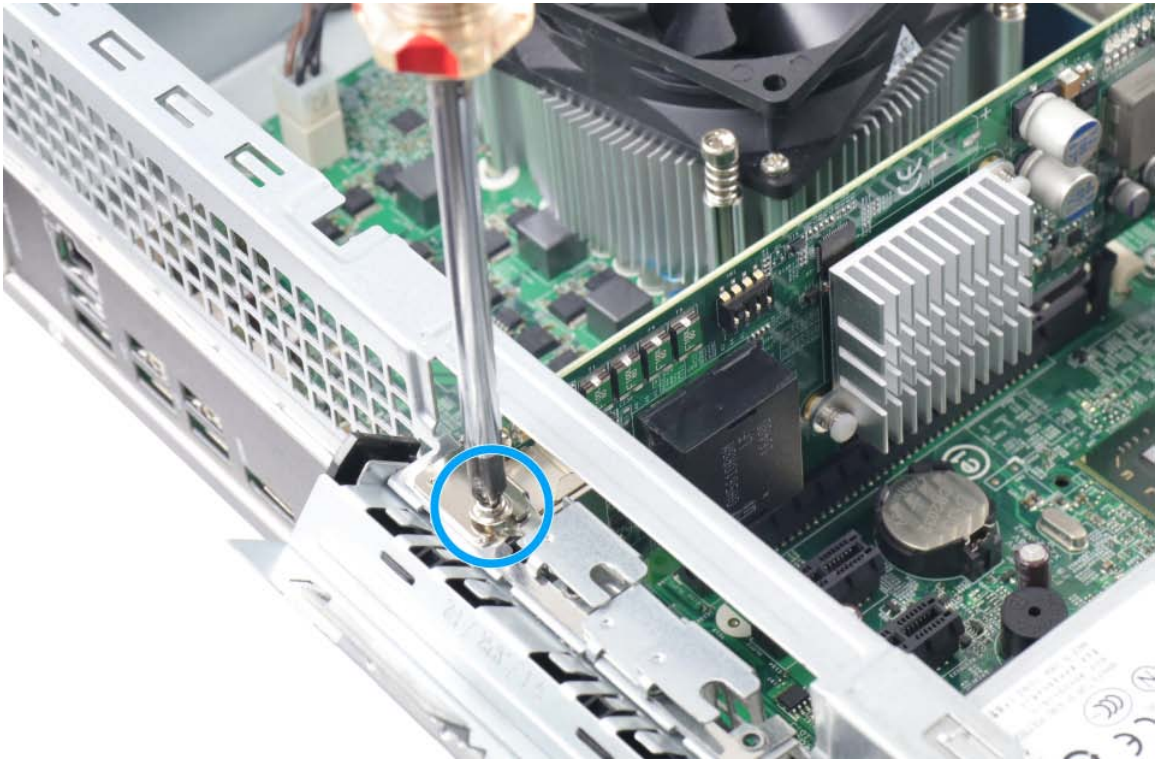

7. Reinstall the system's chassis (panel) to complete the hardware installation process.

3.2 Software Installation

Some operating systems may have built-in drivers included and automatically complete the installation upon entering the system. However, it is still recommended to run and install drivers provided by Neosys to take advantage of all the functions offered. To install the software component, please refer to the following procedure.

1. Plug in the power cable and power up the system.
2. Once you are in the system, insert the Neosys driver DVD included in the package into the DVD-ROM.



3. Locate and execute the driver installation programs according to your operating system:
For Windows XP, execute
`\Driver_Pool\GbE_I210_I350\I350_XP\APPS\PROSETDX\XP2K3_32\DxSetup.exe`
For Windows 7/8.1/10 32-bit, execute
`\Driver_Pool\GbE_I210_I350\Win_ALL_32\APPS\PROSETDX\Win32\DxSetup.exe`
For Windows 7/8.1 64-bit, execute
`\Driver_Pool\GbE_I210_I350\Win_ALL_64\APPS\PROSETDX\Winx64\DxSetup.exe`
For Windows 10 64-bit, execute
`\Driver_Pool\GbE_I210_I350\Win_ALL_64\APPS\PROSETDX\Win10_x64\DxSetup.exe`
4. If your system does not have a DVD-ROM, please go [here](#) to download the latest driver for PCIe-PoE334LP.
5. Simply follow instructions to complete the software installation process.
6. You may begin using your PCIe-PoE334LP after hardware/ software components have been installed.

4 Driver and Network Settings

PCIe-PoE334LP offers Gigabit Ethernet connectivity via Intel® I350-AM4 GbE controller. When connecting to a high-speed PoE device, such as a GigE camera, you can configure driver settings for optimum transmission throughput and connection stability.

4.1 Jumbo Frame

Jumbo frames are Ethernet frames with more than 1500 bytes of payload. By increasing the payload size, large data packets can be transferred with less interruption, which reduces CPU utilization and increases overall data throughput. Intel® I350 GbE controller supports jumbo frame size of up to 9.5 Kbytes. Once the Intel® I350 driver is installed, you may configure jumbo frame settings by executing the following steps:

1. On your keyboard, press **Windows key + E**, right click on **Network** and select **Properties**.

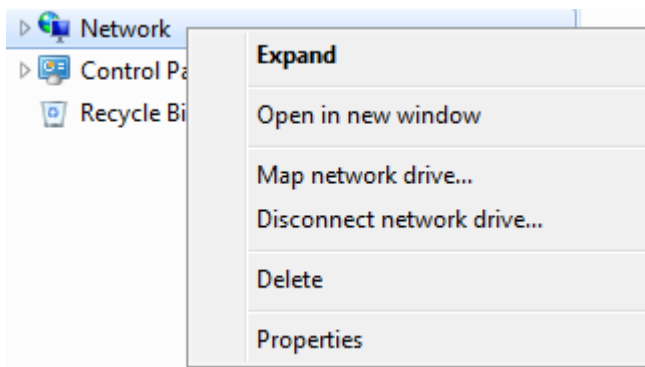

2. Right click on the corresponding **Local Area Connection** (Intel I350 Gigabit Network ...) and select **Properties**.

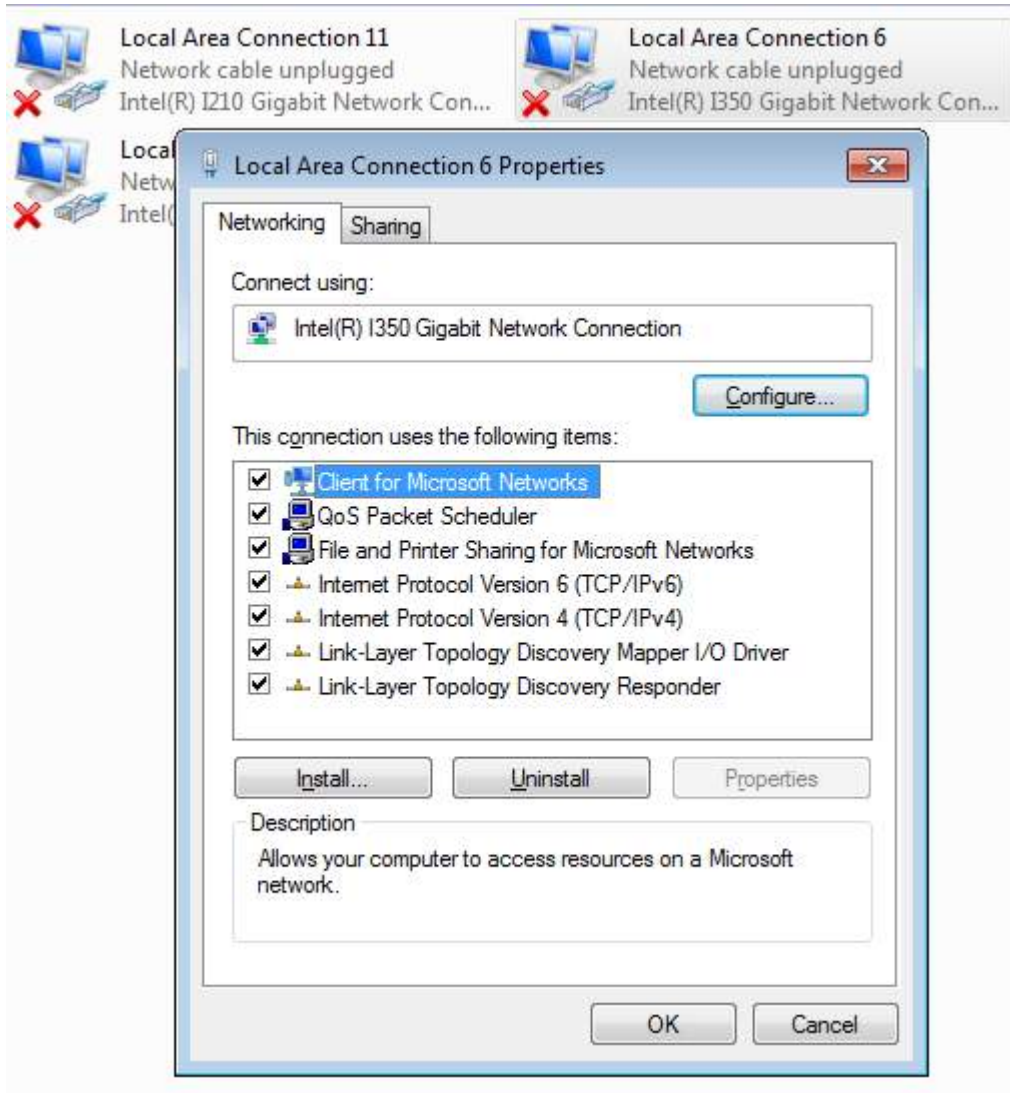

- Click on the **Configure** button, the following dialog appears and click on the **Advanced** tab.

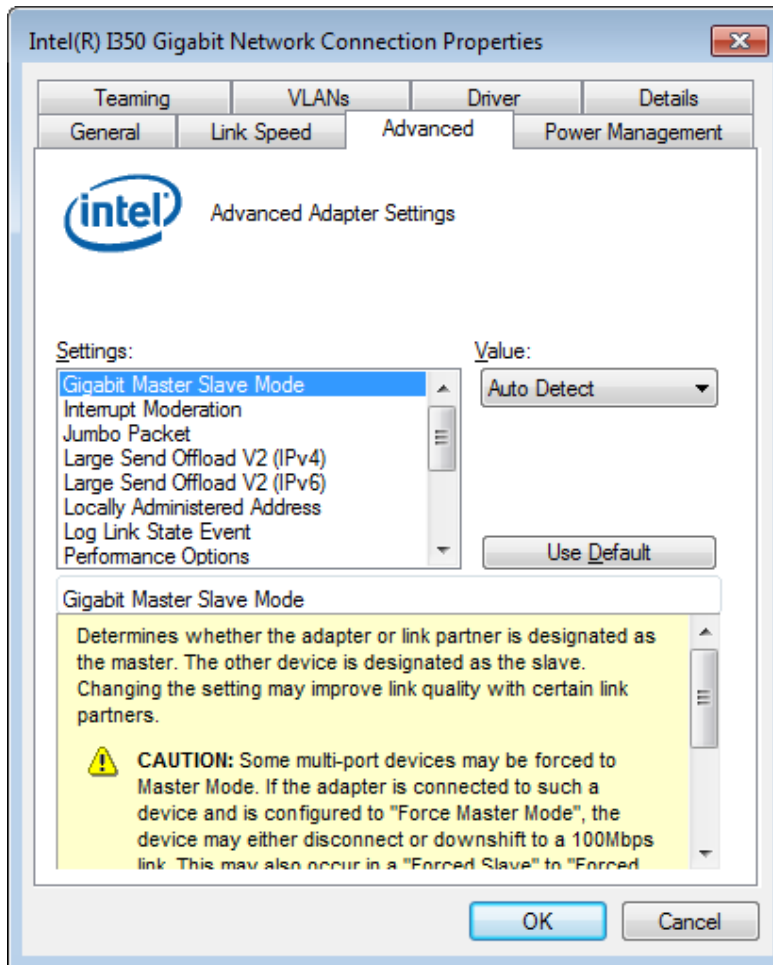

4. Highlight **Jumbo Packet** and select a jumbo frame size from the Value drop-down list (9014 Byte is recommended for connecting devices with high data rate).

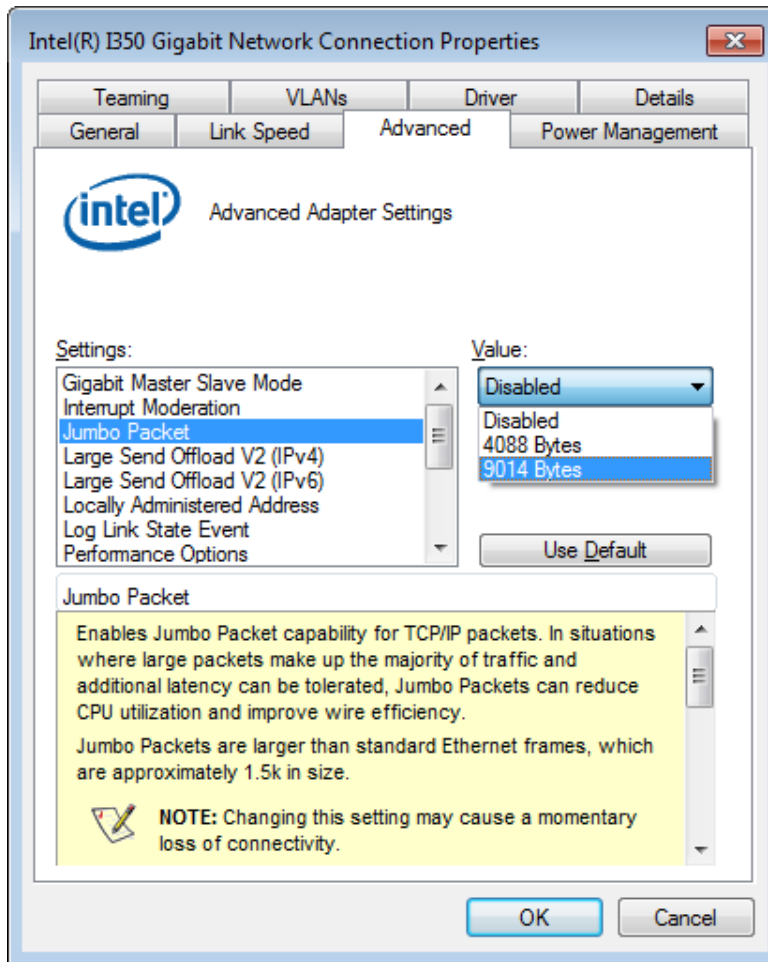

4.2 Receive Buffers

Receive Buffers is another option which can affect data throughput. It determines the size of memory buffer allocated for receiving data. Increasing the size of Receive Buffers can improve the performance of receiving data. The default setting of Receive Buffers is 256 bytes. When connecting to an Ethernet device that generates large amount of data, you can set this option to a larger value (maximum 2048 bytes) for better performance.

To configure Receive Buffers settings, please refer to the following:

1. On your keyboard, press **Windows key + E**, right click on **Network** and select **Properties**.

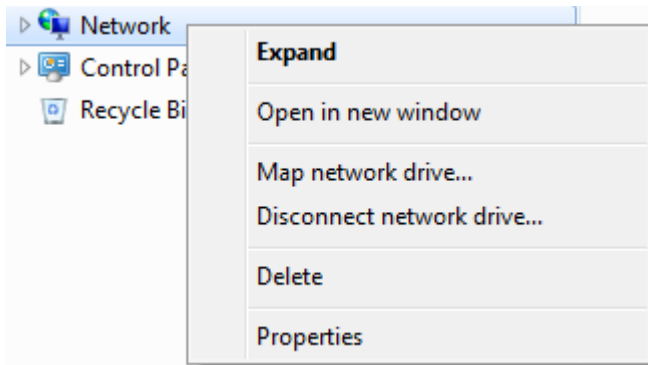

2. Right click on the corresponding **Local Area Connection** (Intel I350 Gigabit Network) and select **“Properties”**.

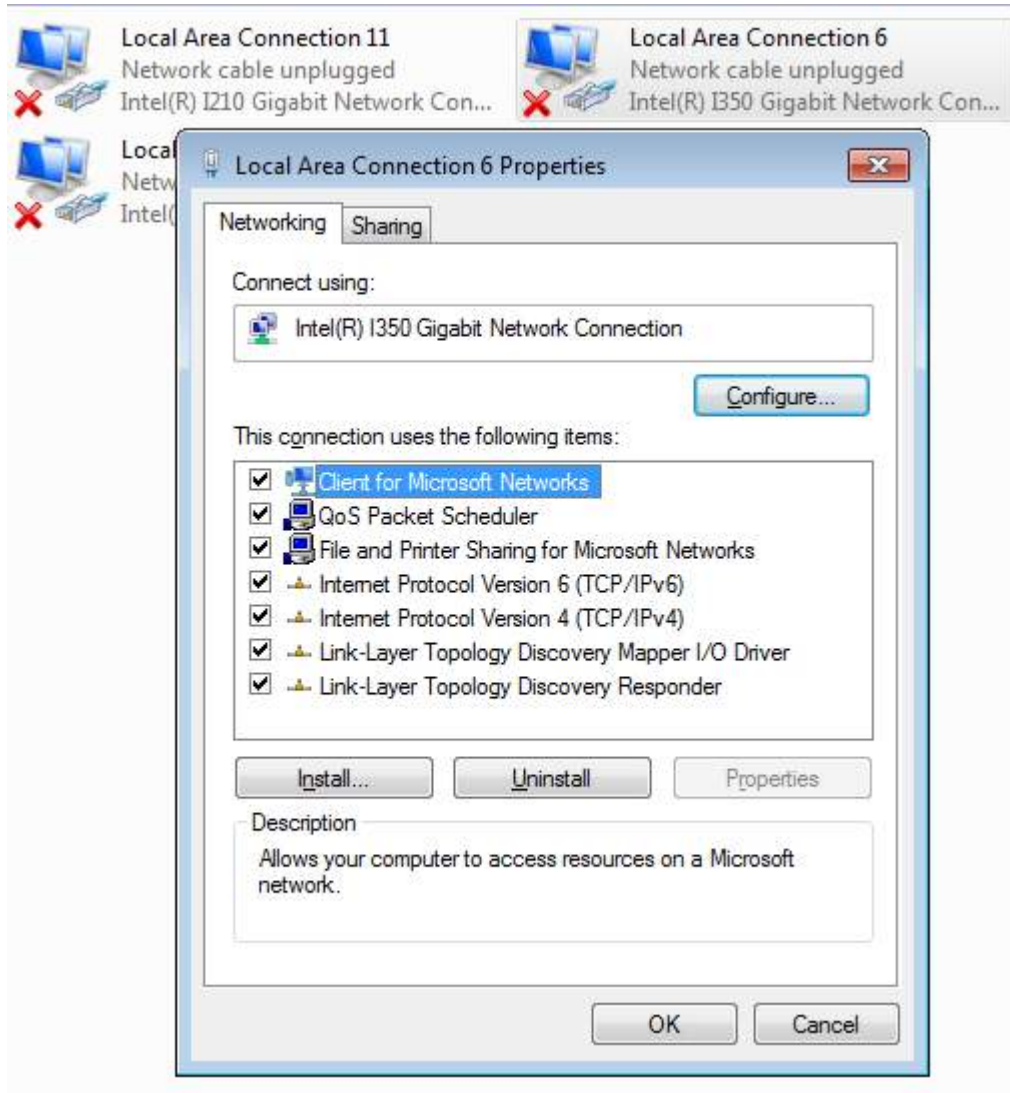

3. Click on the **Configure** button, the following dialog appears and click on the **Advanced** tab.

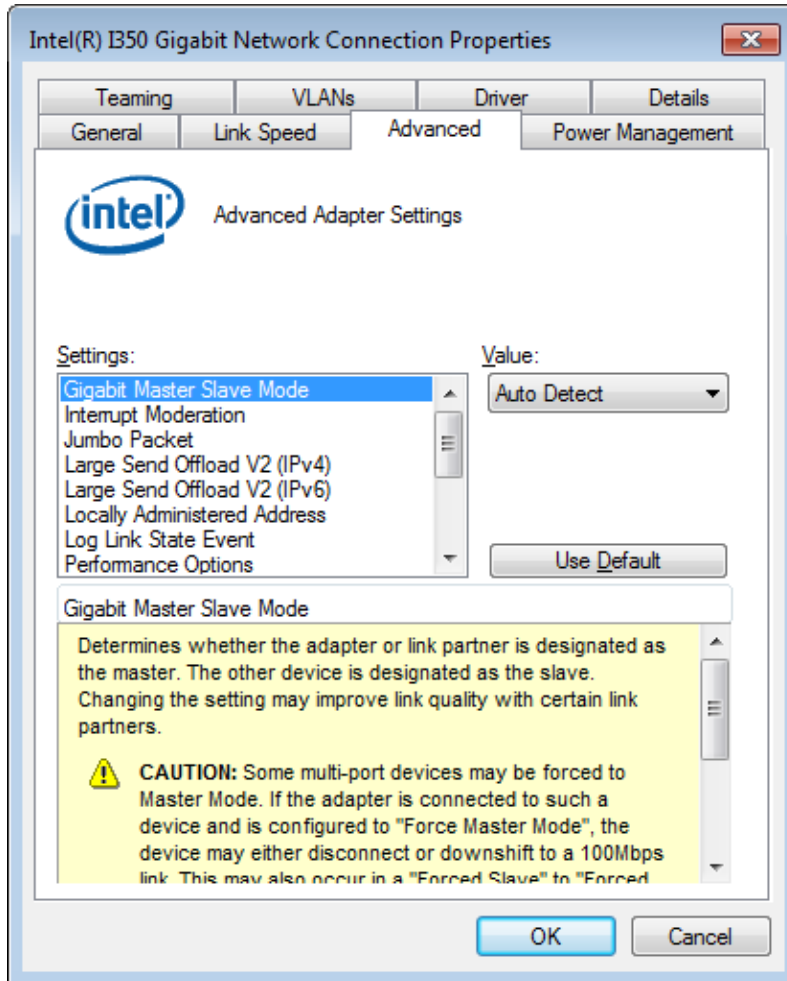

4. Highlight **Performance Options** and click on **Properties**.

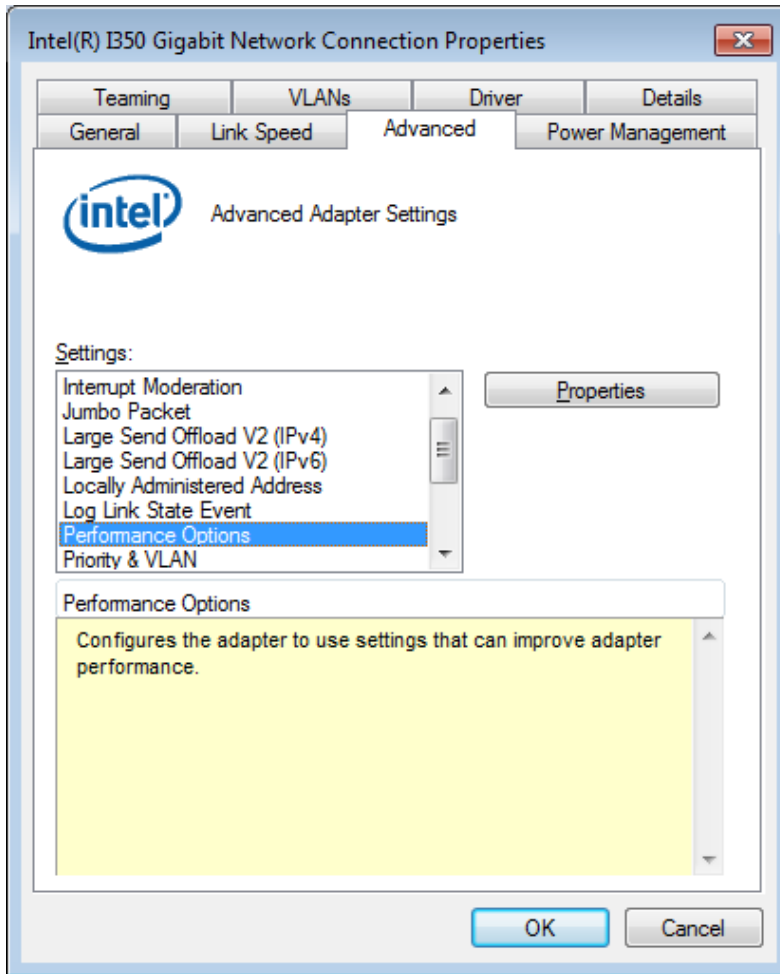

5. Highlight **Receive Buffers** and enter a setting into the **Value** column (2048 Bytes is recommended for connecting devices with high data rate).

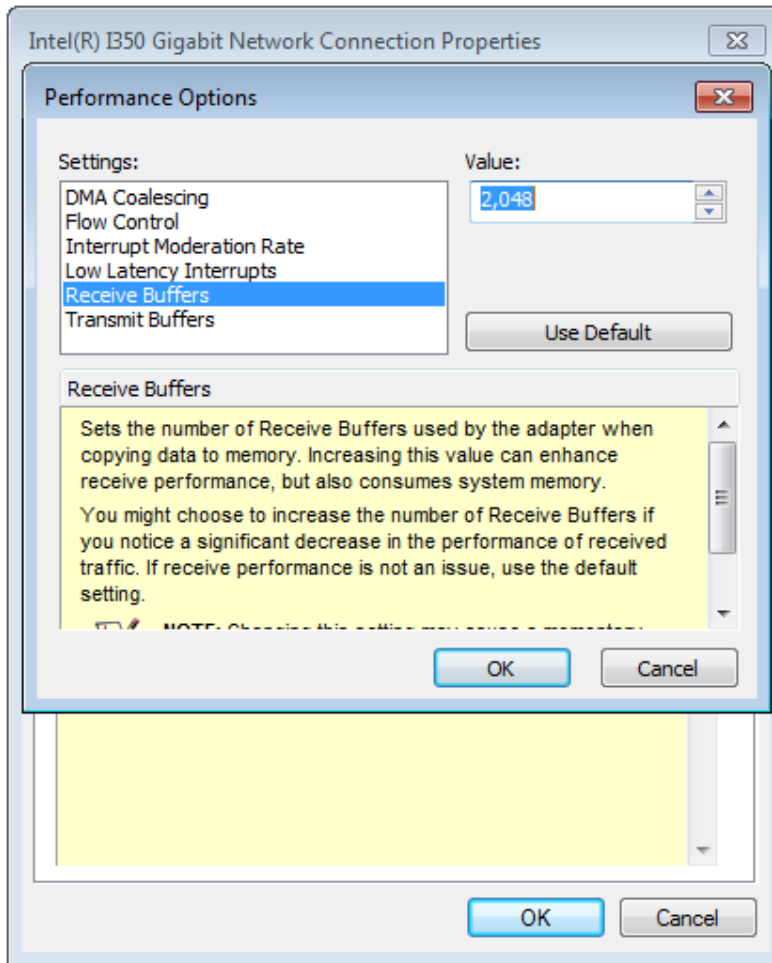

4.3 Transmit Buffers

Like Receive Buffers, Transmit Buffers can affect the transmission performance. The default setting of Transmit Buffers is 512 bytes. If you encounter a performance issue while transmitting data, you can adjust the size of Transmit Buffers to a larger value (maximum 2048 bytes) for better performance.

To configure Transmit Buffers settings, please refer to the following:

1. On your keyboard, press **Windows key + E**, right click on **Network** and select **Properties**.

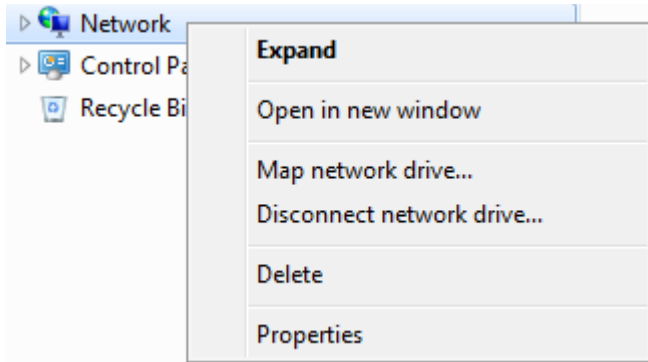

2. Right click on the corresponding **Local Area Connection** (Intel I350 Gigabit Network) and select **Properties**.

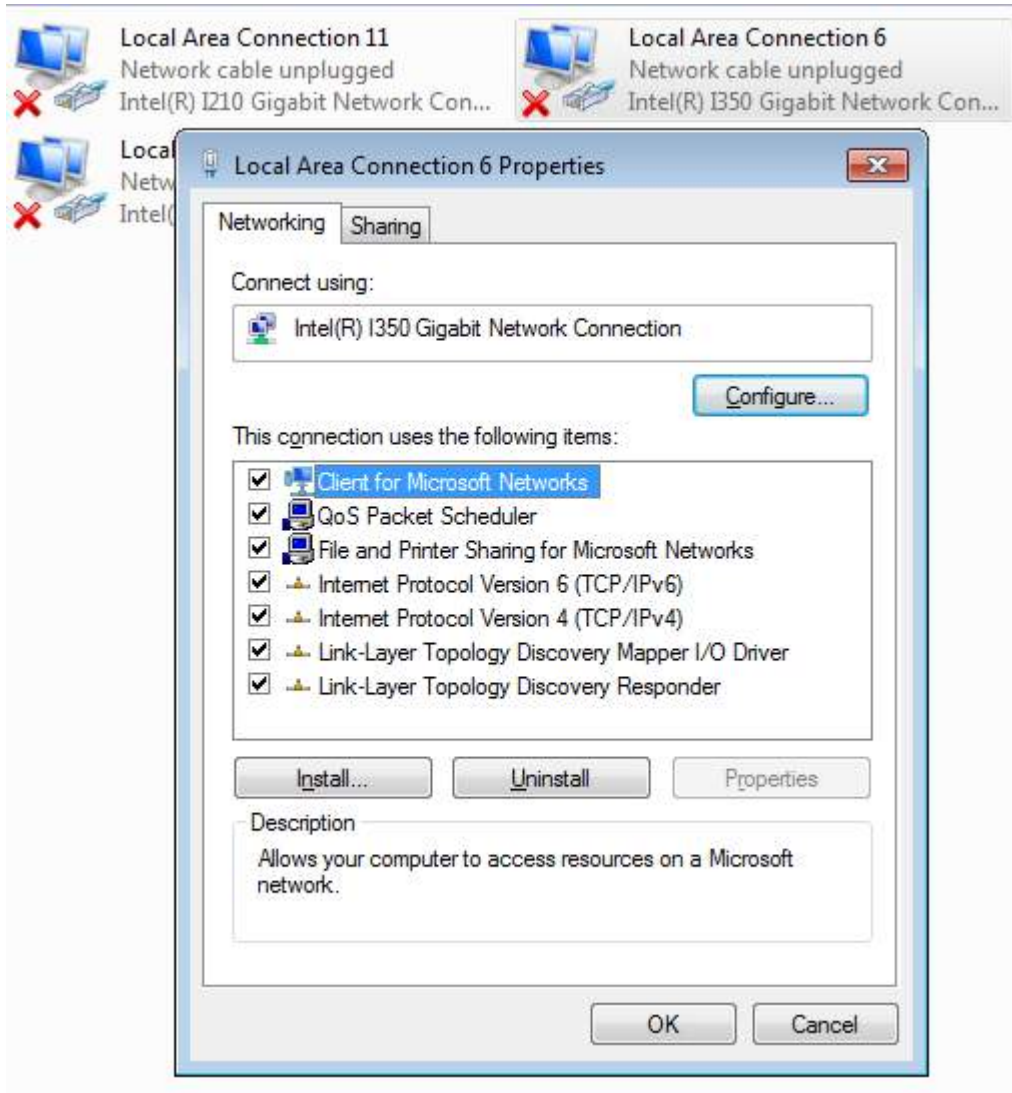

3. Click **Configure** button, the following dialog appears and click on the **Advanced** tab.

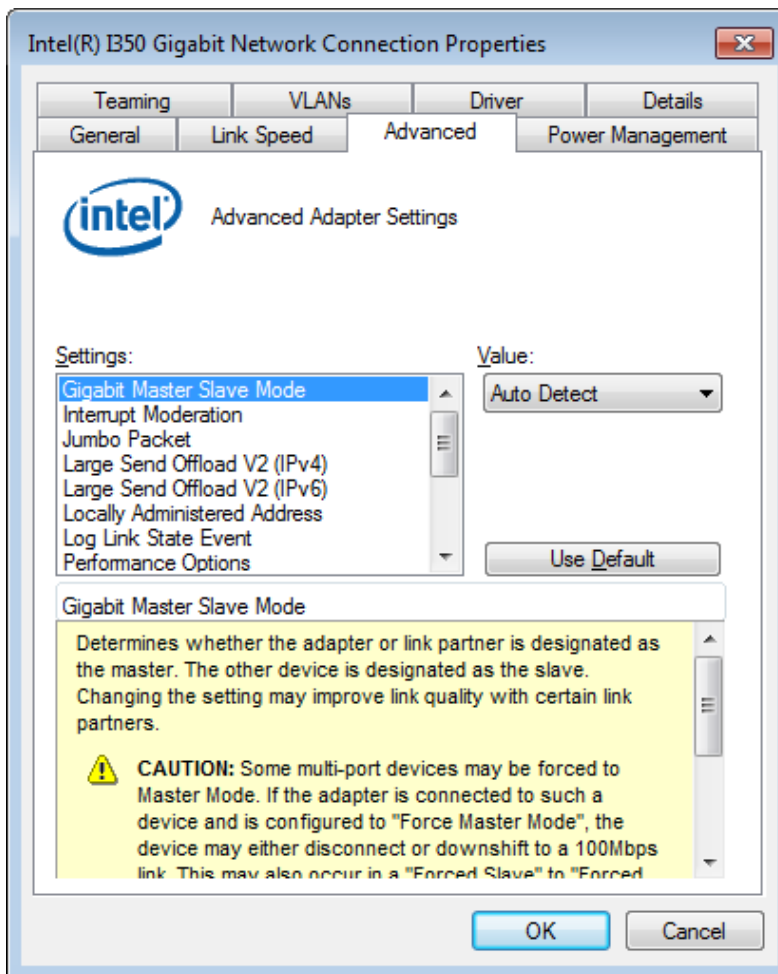

4. Highlight **Performance Options** and click on **Properties**.

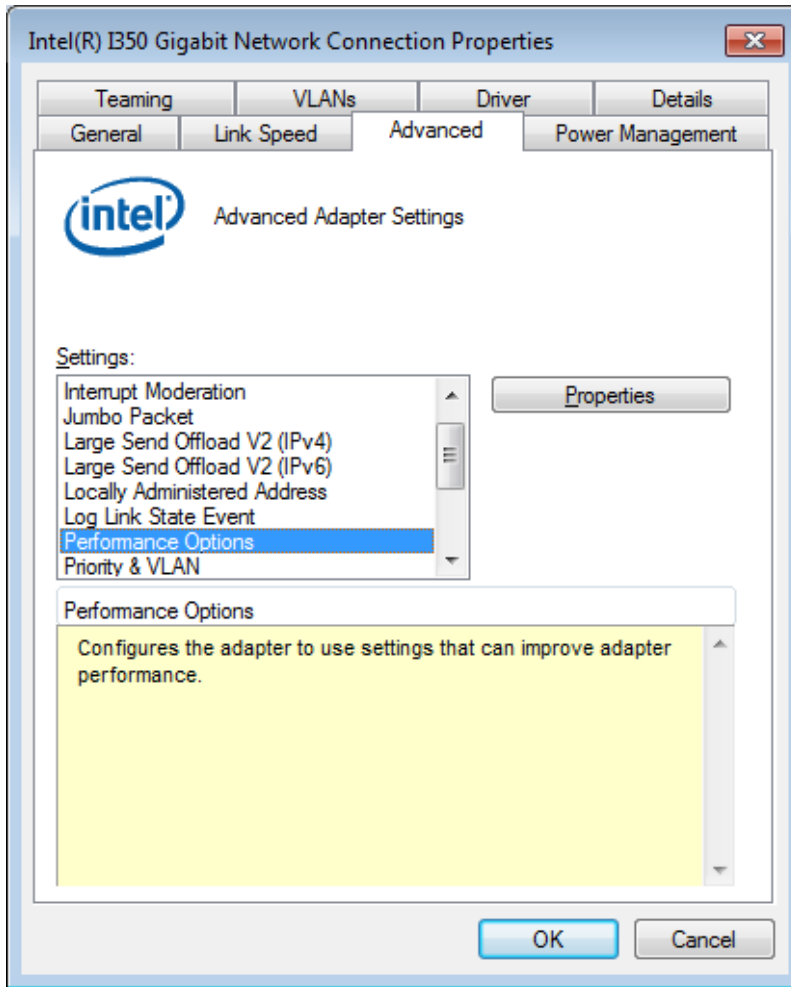

5. Highlight **Transmit Buffers** and enter a setting into the **Value** column (2048 Bytes is recommended for connecting devices with high data rate).

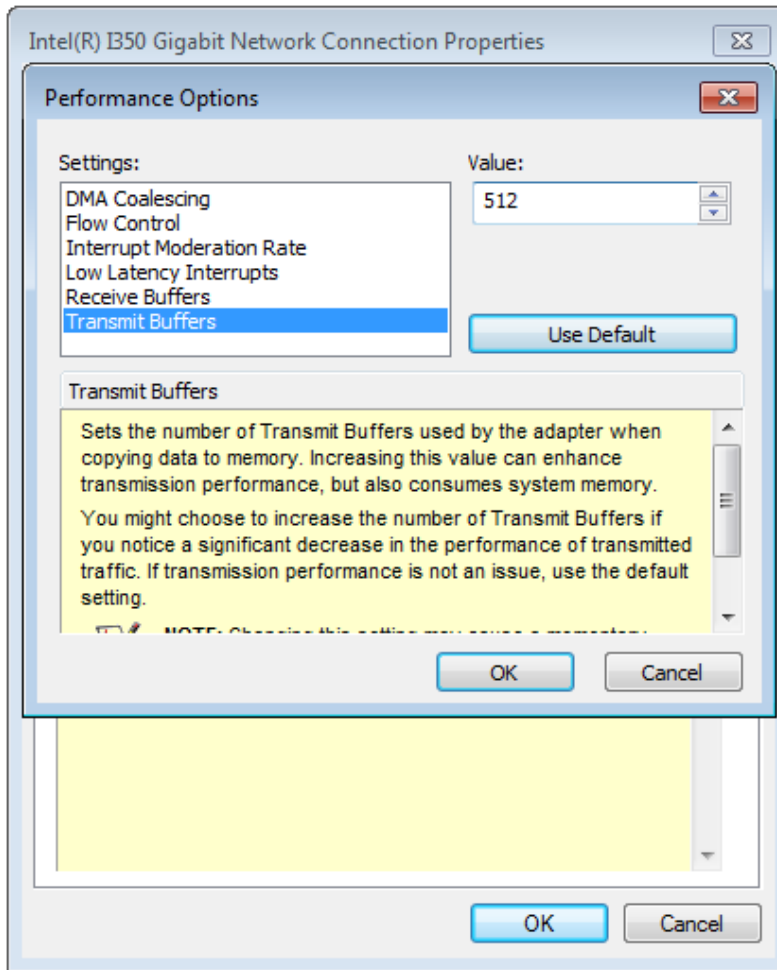

Appendix A Using Per-Port PoE On/Off Control

PCIe-PoE334LP supports power on/off control for each of its PoE ports. With provided function APIs, users can turn on or turn off the power of each PoE port manually for fault-recovery or device power reset purpose. To use the function, you need to install the WDT_DIO_Setup.exe driver package.

**NOTE**

Please install WDT_DIO_Setup_v2.2.9.4 or later versions.

Driver Installation

The per-port PoE on/off control function library is delivered as a part of Neosys driver setup package (WDT_DIO_Setup). Please use **WDT_DIO_Setup_64_v2.2.9.4.exe** or download the latest version from [here](#).

1. Execute **WDT_DIO_Setup_v2.2.9.4.exe**. The following dialog appears.

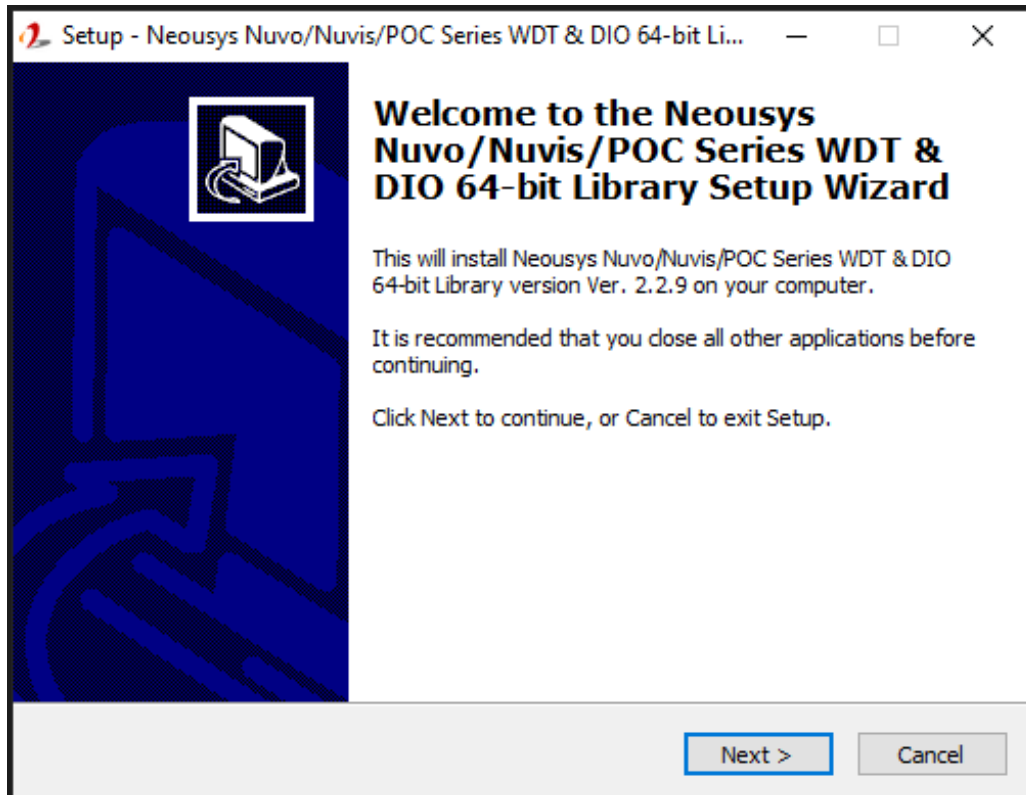

2. Click “Next >” and you may specify a directory you would like to install the files to or you can install to the default directory “C:\Neosys\WDT_DIO”.

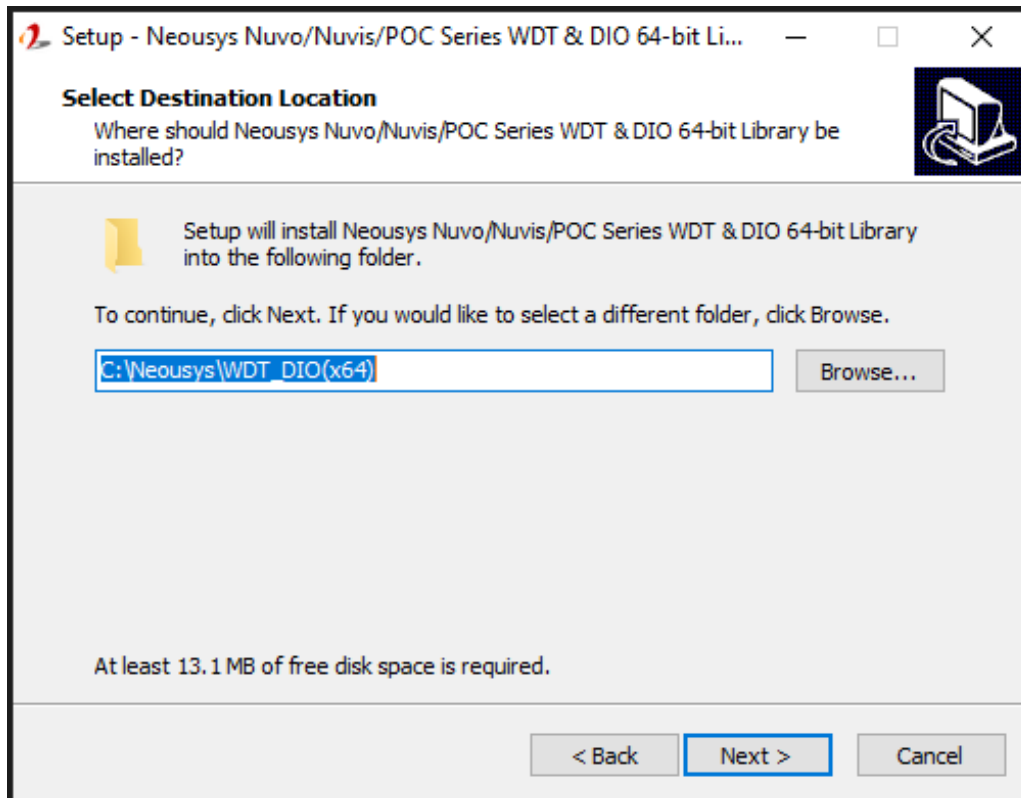

3. Once the installation is finished, a dialog appears to prompt you to reboot the system. The WDT & DIO library will take effect after the system rebooted.

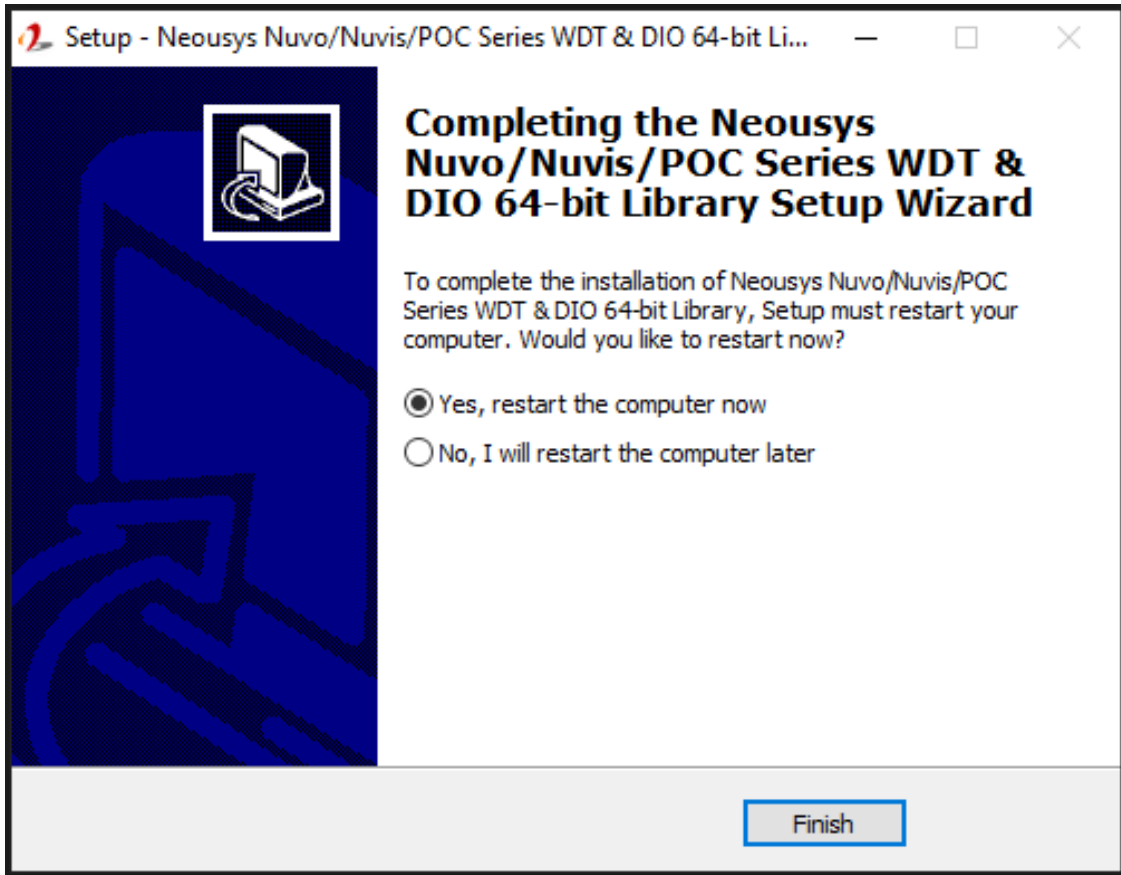

4. When you programming your program, the related files are located in

Header File:	\Include
Library File:	\Lib
Function Reference:	\Manual
Sample Code:	\Sample\POE_Demo (PoE per-port Control Demo)

Per-Port On/Off Control Function Reference

PCI_GetStatusPoEPort

Syntax	BYTE PCI_GetStatusPoEPort(DWORD boardId, DWORD port);
Description	Acquire current power on/off status of designated PoE port.
Parameter	<p>boardId DWORD value (0 ~ 7) to indicate board ID set for your card. Please refer to DIP switch settings for your PCIe-PoE card.</p> <p>port DOWRD value (1 ~ 4) to specify the PoE port.</p>
Return Value	Returns 1 if PoE power is on, 0 if PoE power is off.
Usage	<pre> DWORD boardID; DWORD port; BYTE PoEStatus; //Get PoE power status from board #0, port #1. boardID = 0; port = 1; PoEStatus = PCI_GetStatusPoEPort (boardID, port); </pre>

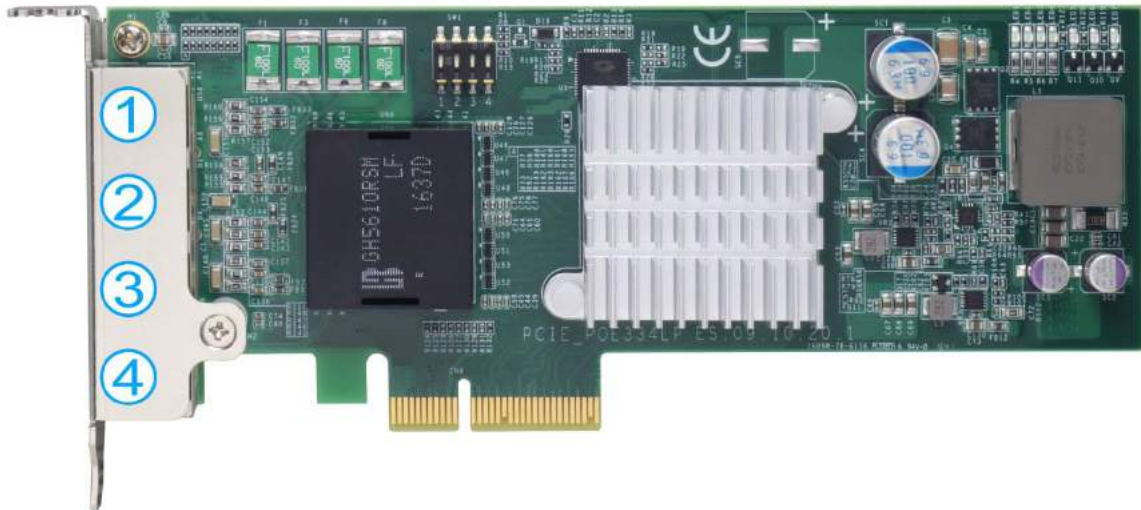

PCI_EnablePoEPort

Syntax	BOOL PCIe_EnablePoEPort(DWORD boardId, DWORD port);
Description	Enable (turn on) PoE power for designated PoE port.
Parameter	<p>boardId</p> <p>DWORD value (0 ~ 7) to indicate board ID set for your card. Please refer to DIP switch settings for your PCIe-PoE card.</p> <p>DOWRD value (1 ~ 4) to specify the PoE port.</p>
Return Value	Returns TRUE if successful, FALSE if failed.
Usage	<pre> DWORD boardID; DWORD port; BOOL RetVal; //Enable PoE power status from board #0, port #1. boardID = 0; port = 1; RetVal= PCIe_EnablePoEPort (boardID, port); </pre>

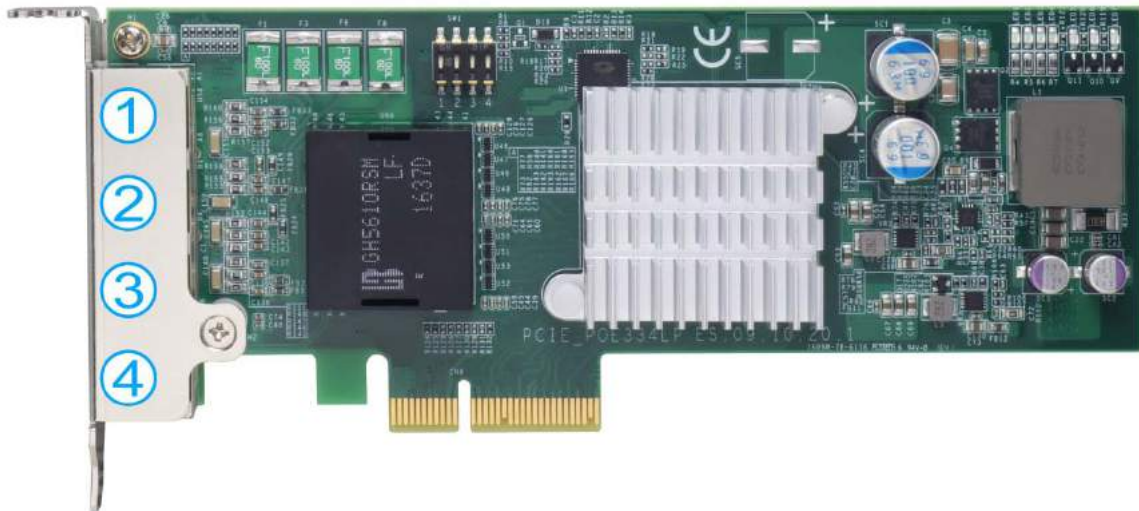

PCI_DisablePoEPort

Syntax	BOOL PCI_DisablePoEPort(DWORD boardId, DWORD port);
Description	Disable (turn off) PoE power for designated PoE port.
Parameter	<p>boardId</p> <p>DWORD value (0 ~ 7) to indicate board ID set for your card. Please refer to DIP switch settings for your PCIe-PoE card.</p> <p>DOWRD value (1 ~ 4) to specify the PoE port.</p>
Return Value	Returns TRUE if successful, FALSE if failed.
Usage	<p>DWORD boardID;</p> <p>DWORD port;</p> <p>BOOL RetVal;</p> <p>//Disable PoE power status from board #0, port #1.</p> <p>boardID = 0;</p> <p>port = 1;</p> <p>RetVal= PCI_DisablePoEPort (boardID, port);</p>

